

15BU Range High Voltage Couplers

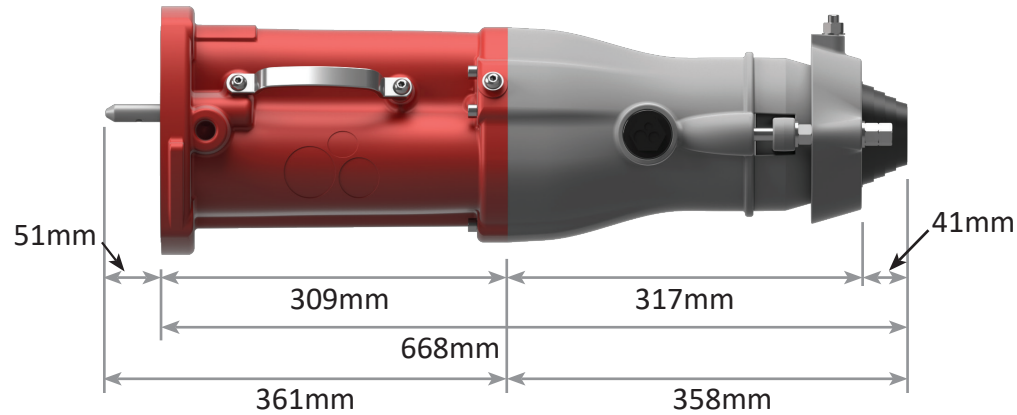

Side View (Armoured)



Front View without Live Line Indicators

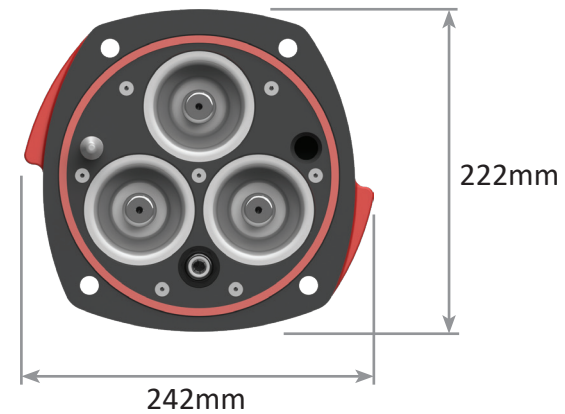

Side View (Unarmoured)

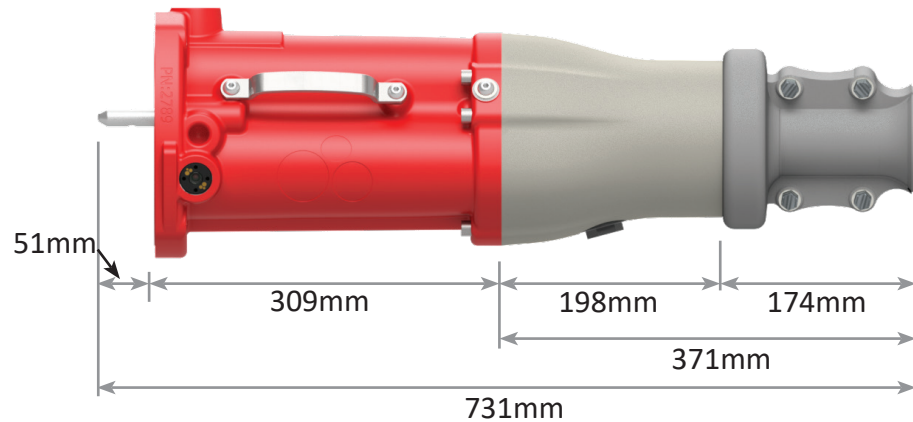

Front View with Live Line Indicators

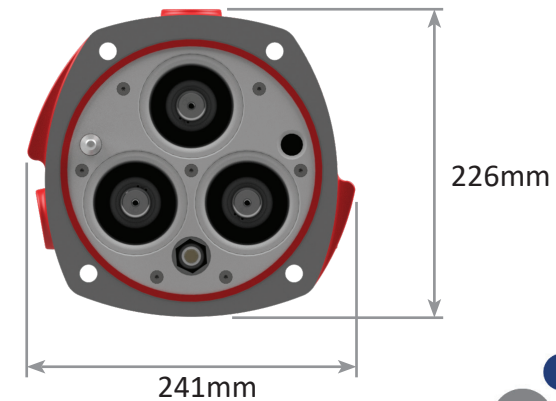

15BU Range High Voltage Adaptors

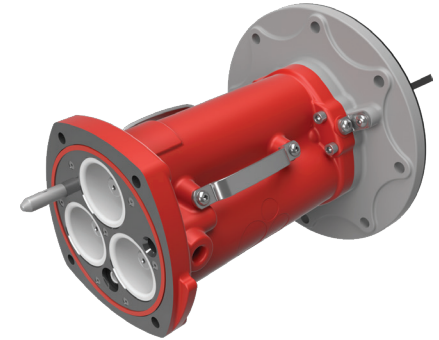

Adaptor Side and Front View

